

MZ SERIES

MINIATURE NON-RESET ELECTRIC COUNTER

- Non-Reset, Super mini size
- Low Cost, Low power consumption
- Suitable for limited space installations in office equipments, amusement equipments, etc.
- Applications : Slot Machine, Copy Machine, Fax Machine, Vending Machine, Other Industrial Machine

MODEL SELECTION

TYPE	MODELS	DIGITS	MOUNTING	CONNECTION	
NON-RESET TOTAL COUNTER	MZ – 600	6	Rear	LEADWIRE	
	MZ – 700	7			
	MZ – 620	6	Base		
	MZ – 720	7			
	MZ – 630	6	Behind Panel (Screw Mount)		
	MZ – 730	7			
	MZ – 640	6	Base		
	MZ – 740	7			
	MZ – 670	6	Panel (Snap-in-type)		
	MZ – 770	7			
	MZ – 602	6	PCB		TERMINAL PIN (Pitch : 12.7 mm)
	MZ – 702	7			
	MZ – 612	6	PCB		TERMINAL PIN (Pitch : 10 mm)
	MZ – 712	7			

SPECIFICATIONS

Display	6 digits : 3.0×2.0mm / 7 digits : 3.0×1.6 (white on black background)
Power Source	DC 12V, 24V
Voltage Fluctuation	-15 ~ +10%
Power Consumption	1.2 W
Continuous Energizing	Permissible
Counting Method	One pulse – One count (energizing – ½ count, unenergized – ½ count)
Counting Speed	10Hz, 20Hz
Pulse Width	50msec. minimum
Make (Duty)	1 : 1
Count Life	6 digits : 3,000,000 counts minimum / 7 digits : 10,000,000 counts minimum
Reset	None
Connection	Leadwire / PCB Type: Pin
Operating Temperature	-5°C ~ +40°C (non-freezing)
Operating Humidity	85%RH maximum (non-condensing)
Test Voltage	AC1,500V for 1 minute
Insulation Resistance	50MΩ minimum (DC500V megger)
Vibration	Endurance : 16.7 Hz, Width : 4mm ; XYZ each direction for 1 hour Mismovement : 10 ~ 55 Hz, Width : 0.5mm ; XYZ each direction for 10 mins.
Shock	Endurance : 294 m/s ² (30G) XYZ 5 times each direction, Total : 30 times Mismovement : 49 m/s ² (5G) XYZ 4 times each direction, Total : 24 times
Construction	Cover : Plastic (Noryl UL94V-1), Black
Weight	30 grams

DIMENSIONS

MZ – 600 • 700

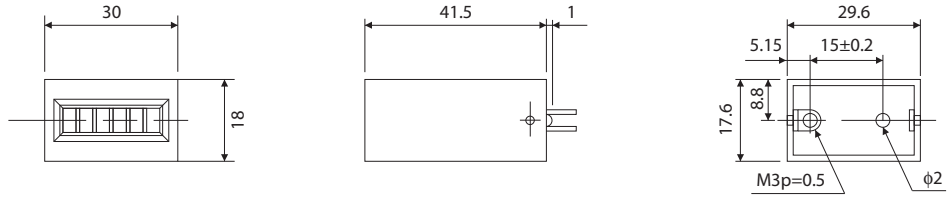

MZ – 620 • 720

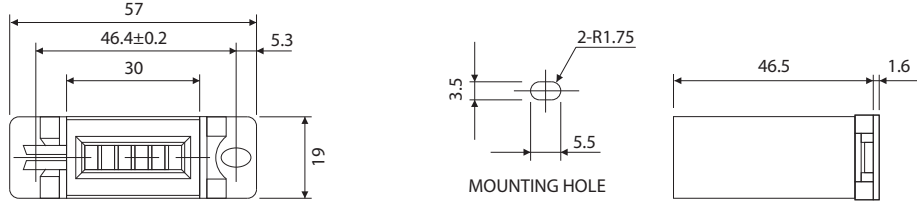

MZ – 630 • 730

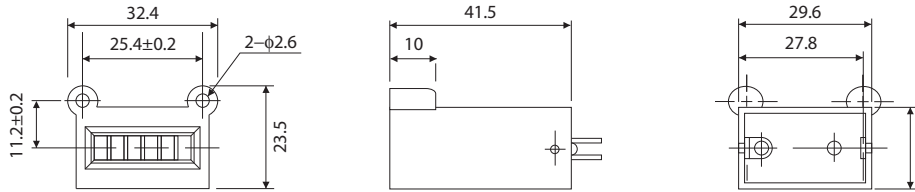

MZ – 640 • 740

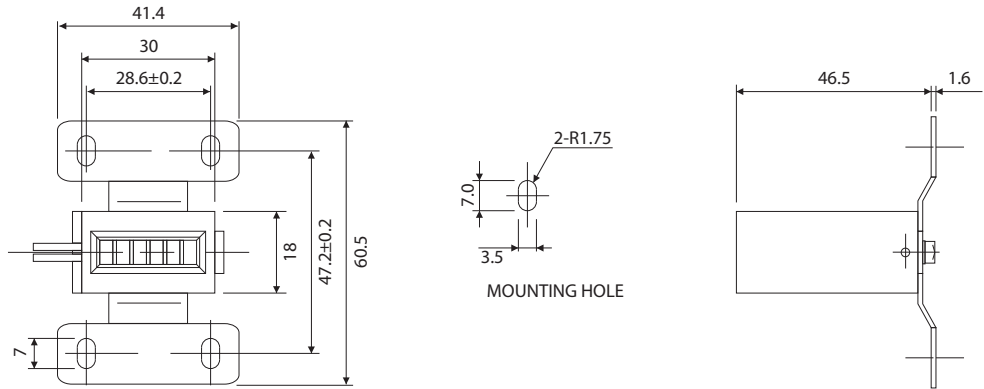

MZ – 670 • 770

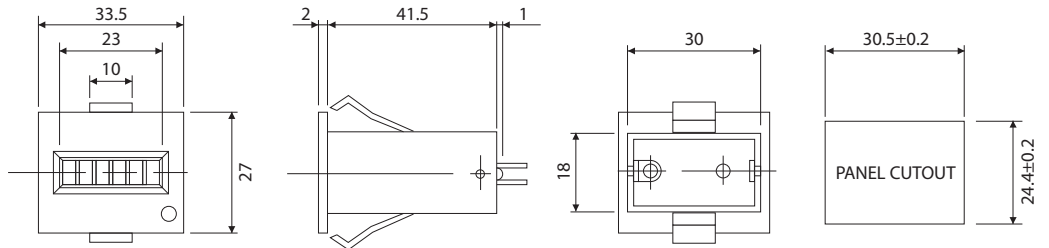

MZ – 602 • 702

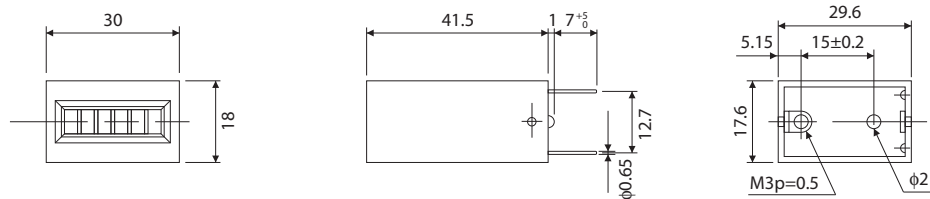

DIMENSIONS

MZ - 612 • 712

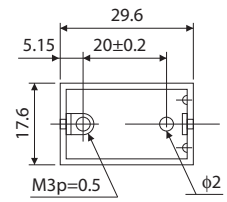
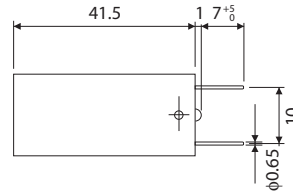
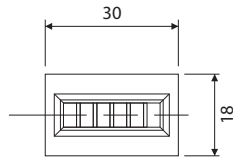

This catalog was last revised Apr. 19, 2010.
*Subject to change without prior notice.
All Rights Reserved, Copyright © 2010, LINE SEIKI CO., LTD.



LINE SEIKI CO., LTD.

Address : 37-7, Chuo-Cho, 2-Chome, Meguro-ku
Tokyo 152-0001 JAPAN

Contacts : Tel: +81-3-3716-5151 Fax: +81-3-3710-4552
E-mail: webtrade@line.co.jp

URL : <http://www.lineseiki.com>